



ReSound Alera™

ReSound LiNX™

ReSound Verso™

ReSound Up Smart™

ReSound ENZO™



User guide

Behind-The-Ear hearing aids

Hearing instrument type designations for models included in this user guide are: **M60**, FCC ID: X26M60, IC: 6941C-M60; **M70-80**, FCC ID: X26M70-80, IC: 6941C-M7080; and **M70-80e**, FCC ID: X26M70-80e, IC: 6941C-M7080e. **LO85**, FCC ID: X26LO85, IC: 6941C-LO85; **LO90**, FCC ID: X26LO90, IC: 6941C-LO90. Please see page 8 for a list of models referring to these types.

Statement:

This device complies with part 15 of the FCC rules and ISED rules.

Operation is subject to the following two conditions: (1) this device may not cause harmful interference, and (2) this device must accept any interference received, including interference that may cause undesired operation.

Note: This equipment has been tested and found to comply with the limits for a Class B digital device, pursuant to part 15 of the FCC rules and ISED rules. These limits are designed to provide reasonable protection against harmful interference in a residential installation. This equipment generates, uses and can radiate radio frequency energy and, if not installed and used in accordance with the instructions, may cause harmful interference to radio communications. However, there is no guarantee that interference will not occur in a particular installation. If this equipment does cause harmful interference to radio or television reception, which can be determined by turning the equipment off and on, the user is encouraged to try to correct the interference by one or more of the following measures:

- Reorient or relocate the receiving antenna.
- Increase the separation between the equipment and receiver.
- Connect the equipment into an outlet on a circuit different from the one in which the receiver is connected.
- Consult the dealer or an experienced radio/TV technician for help.

Changes or modifications can void the user's authority to operate the equipment

Intended use

Generic air-conduction hearing instruments are wearable sound-amplifying devices intended to compensate for impaired hearing. The fundamental operating principle of hearing instruments is to receive, amplify, and transfer sound to the ear drum of a hearing impaired person.

The products are in compliance with the following regulatory requirements:

- In EU: the device conforms to the Essential Requirements according to Annex I of Council Directive 93/42/EEC for medical devices (MDD).
- Hereby, GN ReSound A/S declares that the radio equipment types M60, M70-80, M70-80e, L085 and LO90 are in compliance with Directive 2014/53/EU.
- The full text of the EU declaration of conformity is available at the following internet address: www.declarations.resound.com
- In US: FCC CFR 47 Part 15, subpart C.
- Other identified applicable international regulatory requirements in countries outside the US. Please refer to local country requirements for these areas.
- Canada: these hearing instruments are certified under the rules of ISED.
- Cet appareil numérique de la classe B est conforme à la norme ISED du Canada.
- Japanese Radio Law and Japanese Telecommunications Business Law Compliance. This device is granted pursuant to the Japanese Radio Law (電波法) and the Japanese telecommunications Business Law (電気通信事業法) This device should not be modified (otherwise the granted designation number will become invalid)
- Patents
US 7,593,537 US 8,00,849

ReSound is a registered trade mark of GN ReSound A/S

Introduction

Congratulations on the purchase of your new hearing instruments. ReSound's innovative sound technology and design, combined with the customized programming selected by your hearing care professional, will make hearing a more enjoyable experience. Hearing instruments will enable you to hear sounds that you may not have heard in years because of your hearing loss. Practice and a positive attitude are important in learning to use hearing instruments. Your ReSound instruments have been adjusted according to your individual hearing loss and needs. Some people adjust quickly to wearing hearing instruments in their ears and hearing new sounds; other people may need more time.

Please read this manual carefully in order to wholly benefit from the use of your hearing instruments. With proper care, maintenance, and usage, your hearing instruments will aid you in better communication for many years. Ask your hearing care professional if you have any questions.

Hearing instrument model: _____

Model 67: Battery size 312

Model 77: Battery size 13

Model 87/88: Battery size 13

Model 98: Battery size 675

Tube type: _____

Dome size: _____

Left serial number: _____

Right serial number: _____

Contents

Introduction	5
Getting started	10
SmartStart	11
Inserting/Replacing the battery	11
Low battery indicator	12
Low battery indicator (instruments paired with accessories only)	12
Inserting/Removing hearing instruments	13
Operation of the hearing instrument	16
Flight mode*	20
Telephone use	22
Listen to radio or TV	22
Using ReSound Hearing Instruments with iPhone®, iPad®, and iPod touch® (ReSound LiNX, Enzo and Up Smart)	23
Cellular phones	23
PhoneNow	23
Telecoil (optional)	26
Tele-loop systems	26
FM and Direct audio input (optional)	26

Connecting/Disconnecting direct audio boot or integrated FM	27
Important points for FM	29
Battery door lock (optional)	30
i Important guidelines:	31
Care and maintenance	34
Daily maintenance	35
Cleaning earmolds	35
Cleaning thin tubes and domes	35
Cleaning metal hook	36
How to apply domes	36
Using ReSound hearing instruments with smart phone apps	37
General precautions	38
General warnings	39
Tinnitus Sound Generator (TSG) module	41
Intended use for the TSG module	41
TSG warnings	41
User instructions for the TSG module	41
TSG precautions	43

The scientific concepts that form the basis for the device	43
Significant physical characteristics	44
Important notice for prospective sound generator users	45
Battery warning information	47
Hearing instrument expectations	47
Warning to hearing aid dispensers (US Only)	48
Technical data	51
Troubleshooting Guide	59
Warranty and repairs	62
Temperature test, transport and storage information	62

Mini behind-the-ear (BTE) hearing instruments of type M60 with FCC ID X26M60, IC number 6941C-M60 and size 312 battery are available in the following variants:

AL967-DIW, AL767-DIW, AL567-DIW, AL467-DIW, ALT967-DIW, ALT767-DIW, VO967-DW, VO767-DW, VO567-DW, VOT967-DW, VOT767-DW, UP967-DW, UP767-DW

Behind-the-ear (BTE) hearing instruments of type M70-80 with FCC ID X26M70-80, IC number 6941C-M7080 and size 13 battery are available in the following variants:

AL977/87-DVIW, AL777/87-DVIW, AL577/87-DVIW, AL477/87-DVIW, ALT977/87-DVIW, ALT777/87-DVIW, ALT577/87-DVIW

Behind-the-ear (BTE) hearing instruments of type M70-80e with FCC ID X26M70-80e, IC number 6941C-M7080e and size 13 battery are available in the following variants:

VO988-DW, VO977-DW, VO788-DW, VO777-DW, VO588-DW, VO577-DW, VOT988-DW, VOT977-DW, VOT788-DW, VOT777-DW, UP988-DW, UP988-DLW, UP977-DW, UP977-DLW, UP788-DW, UP788-DLW, UP777-DW, UP777-DLW

Behind-The-Ear (BTE) hearing instruments type LO85 with FCC ID X26LO85, IC number 6941C-LO85 and size 13 battery are available in following variants:

UPS988-DLW, UPS788-DLW, UPS588-DLW, UPS588M-DLW, UPS977-DLW, UPS777-DLW, UPS577-DLW, UPS577M-DLW, LN977-DW, LN777-DW, LN577-DW, LNT977-DW, LNT777-DW, LN988-DW, LN788-DW, LN588-DW, LNT988-DW, LNT788-DW

Super Power Behind-The-Ear (SP BTE) hearing instruments type LO90 with FCC ID X26LO90, IC number 6941C-LO90 and size 675 battery are available in following variants:

EO998-DW, EO798-DW, EO598-DW, UPS998-DLW, UPS798-DLW, UPS598-DLW, UPS598M-DLW

The identification number for the M60, M70-80, M70-80e, LO85 and LO90 device models can be found at location "10" as indicated in the illustrations on the next page.

1. Program button
2. Battery compartment & On/Off switch
3. Sound outlet
4. Front microphone inlet
5. Back microphone inlet
6. Volume control (optional)
7. Direct audio input
8. Left/Right indicator (Left=Blue/Right=Red)
9. Battery lock (optional)
10. Model
11. Manufacturer
12. Serial number
13. LED indicator (optional)
14. Battery lock release (optional)
15. Earhook
16. Earmold and tubing
17. Thin Tube
18. Domes/earmold
 - a. Open dome
 - b. Tulip-Dome
 - c. Custom earmold
19. Sports lock (optional)

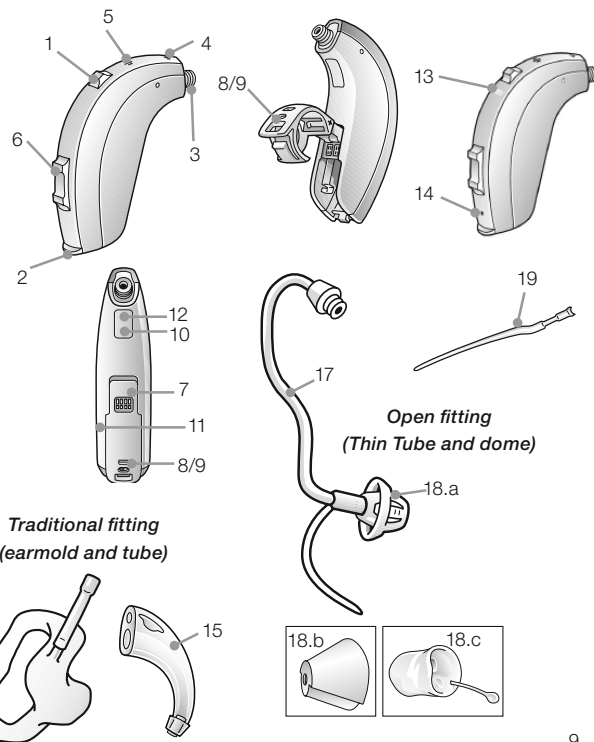

- 8. Left/Right indicator (Left=Blue/Right=Red)
- 13. LED indicator (optional)
- 14. Battery lock release (optional)

Getting started

On/Off function

1. When the battery door is closed, the hearing instrument turns on, and the default program will be activated.
2. To turn off the hearing instrument, open the battery door. Many individuals can use their fingernail to pull it open.

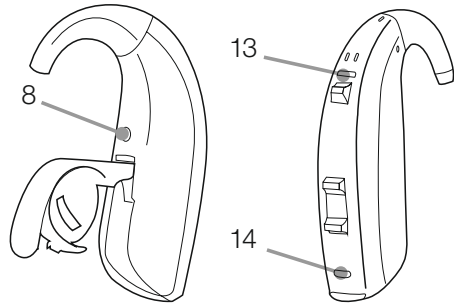

i Tip: For 70/80 models the DAI boot or integrated FM must be removed before battery door will open.

SmartStart

Hearing instruments can be turned on once you have placed them on your ears. If you prefer to turn them on just prior to placing them on your ear, your hearing care professional can activate a function called SmartStart. This function will delay the time in which the hearing instruments turn on after the battery compartment is closed. With SmartStart, a beep will be heard for each second of the delay period.

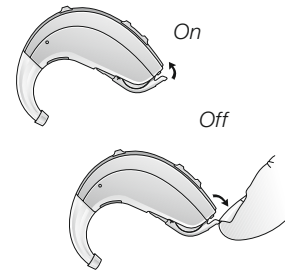

Inserting/Replacing the battery

1. Open the battery door completely by using your fingernail. Remove the used battery if present.
2. Prepare the new battery (please refer to page 5 for information on appropriate battery type/size for your hearing instrument). Remove the protective foil and wait 2 minutes before inserting the battery into the hearing instrument to allow activation of the battery.
3. Insert the new battery with the positive side in the correct position.
4. Gently close the battery door.

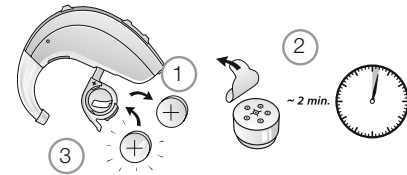



Tip:

1. Always use new Zinc-Air batteries that have a minimum remaining shelf life of 1 year.
2. Whenever the hearing instruments are not in use, remember to turn them off to avoid unnecessary battery consumption.
3. Remove the sticker from the battery and let it air for 2 minute before you insert it.
4. If hearing instrument is experiencing frequent loss of connection to ReSound Unite accessories, contact your hearing care professional for a list of low impedance batteries.

Low battery indicator

Your hearing care professional can activate a low battery indicator in your hearing instruments. The hearing instrument will reduce amplification and play a melody if battery power gets too low. This signal will recur every five minutes (every 15 minutes for the LiNX, ENZO and Up Smart models) until the hearing instrument automatically switches off. The timing of the low battery indicator can vary slightly, depending on the type of battery used. It is recommended that you keep spare batteries on hand.

Low battery indicator (instruments paired with accessories only)

Active usage of the ReSound Unite accessories (Remote Control, Phone Clip, TV streamer and Mini Microphone) or an FM receiver requires more battery power from the hearing instruments than when they are working without accessories which means that battery life is highly dependent on the amount of wireless accessory usage. When the battery in the hearing instrument has depleted to a level at which use of ReSound Unite TV Streamer, Phone Clip and Mini Microphone cannot be supported, the hearing instrument will play two sets of descending tones.

After this, your hearing instrument and ReSound Unite Remote Control will continue to work as usual, but you will not be able to use your ReSound TV Streamer, Phone Clip, and Mini Microphone. At some point the battery level will also be too low to support the remote control as well and you will once again hear the descending tones. The hearing instruments will continue to work as usual. Once a new battery is inserted, full operation of the accessories will resume.

Inserting/Removing hearing instruments

Insertion (custom earmolds)

1. Hold the earmold between your thumb and index finger and position its sound outlet in your ear canal.
2. Slide the earmold all the way into your ear with a gentle, twisting movement.
3. Turn the top part of the earmold gently backwards and forwards so that it tucks behind the fold of skin above your ear canal.
4. Move the earmold up and down and gently press to ensure it is positioned correctly in the ear. Opening and closing your mouth can ease insertion.
5. Make sure the hearing instrument is seated behind the ear.

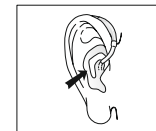
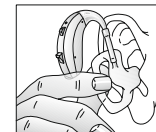

By experimenting, an easier method may be discovered. With proper insertion, hearing instruments should fit snugly but comfortably. If the hearing instruments cause irritation of the ears, contact your hearing care professional.

 Note: Never attempt to modify the shape of the hearing instrument, earmolds, or tubing yourself.

 Tip: It may be helpful to pull your ear up and outward with your opposite hand during insertion.

Removal (custom earmolds)

1. Hold a portion of your earmold towards the back of the ear.
2. Pull the earmold outward and simultaneously rotate the earmold forward.
3. Consult your hearing care professional if you have difficulties removing the hearing instrument.

Insertion (domes/custom earmolds with thin tubes)

1. Hold the thin tube where it bends, and gently place the dome into the ear canal. Push the dome far enough into the ear canal so that the thin tube lies flush with the head.
2. It is important that the tube and the dome fit correctly into your ear.
3. When the dome is placed correctly, you should not be able to see the thin tube sticking out when facing a mirror.

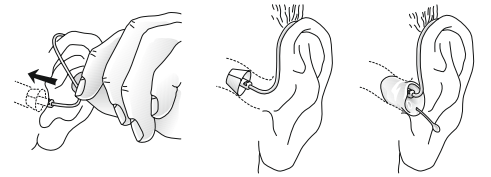

 Note: You should never attempt to bend or modify the shape of the thin tube.

Removal (domes/custom earmolds with thin tubes)

1. Hold the thin tube with your thumb and forefinger and remove the tube.
2. For thin tube custom earmolds, grasp the removal string and pull the earmold outward.
3. Consult your hearing care professional if you have difficulties removing the hearing instrument.

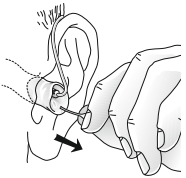

Sports lock

The Sports lock will be applied or adjusted by your hearing care professional.



Operation of the hearing instrument

Volume control (optional)

The volume control will allow the volume of hearing instruments to be increased or decreased.

1. To increase the volume, push the volume control up.
2. To decrease the volume, push the volume control down.

When volume is increased or decreased, a beep signal will be heard for each incremental change. When the upper or lower limits of the volume range are reached, a beep signal with a longer duration will be heard.

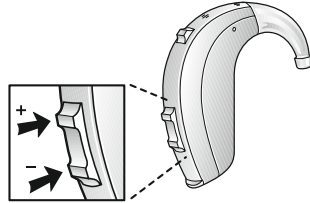

If you have two hearing instruments with the synchronization function enabled, volume control adjustments to one instrument will automatically repeat in the second instrument. When a volume control adjustment is made in one instrument, you will hear a confirmation beep. A beep in the second instrument will follow.

Your hearing care professional can disable the volume control function if it is not desired. The volume control can also be replaced with a non-functional cover.

Super Power can be programmed with additional function for the volume control on down button long press. Your hearing care professional can program it to act as:

- Minimum volume - device will drop volume to minimum set by the dispenser
- Power down - stand by mode, device will stop amplifying sounds until activated again. Note that device is not switched off in that mode

To return to previous state press volume control down button long press.

Program button

Depending on your experience level with hearing instruments, individual hearing needs, and the type of listening environments you experience, your hearing care professional may activate additional programs. If additional programs have been activated, the following list explains how they work.

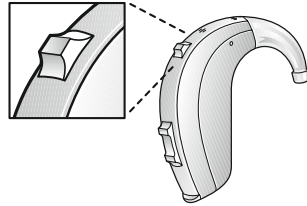

Program	Description of when to use
1	
2	
3	
4	

1. You can switch between programs by pushing the push button once.
2. You will then hear one or more beeps. The number of beeps indicates which program you have selected (one beep = program one, two beeps = program two, etc.).
3. When the hearing instruments are turned off and then back on, the hearing instrument always returns to the default setting (program one).

If you have two hearing instruments with the synchronization function enabled, program changes to one instrument will automatically repeat in the second instrument. When a program change is made in one instrument, you will hear the same amount of confirmation beeps in the second instrument.

LED Indicator (optional)



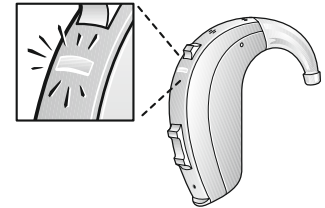







Some paediatric hearing instruments are equipped with a visual indicator which blinks to show the instrument status. Your hearing care professional can activate the LED indicator either to show only control changes (such as increasing or decreasing volume or changing program) or both control changes and periodic status updates. The LED indicator can also be disabled.



When enabled, the LED indicator will light continuously for several seconds when the instrument is turned on. If Wireless Flight Mode is activated, this indication changes to a double-blink series (see Flight Mode, page 20).

When enabled, the LED indicator will blink whenever the program button is pressed. The number of blinks indicates which program you have selected (one blink = program one, two blinks = program two, etc.). When activating audio streaming from a ReSound Unite accessory (Phone Clip, TV Streamer or Mini Microphone or when an FM / DAI audio program is selected, the connection will be indicated by a long blink followed by a short. Volume change (up or down) is indicated by a short blink. A volume limit is indicated with a long blink.

If status indications are enabled, the LED indicator will blink every 5 seconds to show in which program the hearing instrument is operating. The blink pattern associated with each program is illustrated in the table on the next page. Low Battery is indicated by a rapid series of blinks followed by a short pause then the series is repeated again until the battery is full discharged. Your hearing care professional can demonstrate the various blinks during the hearing instrument fitting.

Startup Signal	Normal Start	
	Flight Mode	
Change Program	Program 1	
	Program 2	
	Program 3	
	Program 4	
	FM / Streamer	
Change Volume	Volume Up/Down	
	Volume Limit	
	Low Battery	

Flight mode*

When boarding a flight **or entering an area where RF transmitters are prohibited**, wireless functionality must be deactivated, as it is not allowed to radiate radio signals during flights or in otherwise restricted areas.

For Alera wireless hearing instruments follow the following steps to enter and leave flight mode:

It is possible to disable wireless operation by opening and closing the battery compartment of the hearing instrument while at the same time pressing the push button.

When disabled manually, wireless operation may be re-enabled by opening and closing the battery compartment normally, (i.e. without at the same time pressing the push button).

For ENZO, LiNX, Verso, Up and Up Smart wireless hearing instruments follow the following instructions to enter and leave flight mode:

It is possible to disable wireless operation by opening and closing the battery compartment three times within a ten second period (open-close, open-close, open-close). Your instruments will now be in flight mode.

If the hearing instrument is in flight mode, the hearing instrument must have been operating in flight mode for at least 10 seconds before attempting to enable wireless again. It is possible to re-enable wireless operation by opening and closing the battery door once. 10 seconds after this operation is completed, wireless operation will begin again.



Note: It is important to wait an additional 15 seconds after wireless function resumes before opening and closing the battery compartment again for any reason. If the battery compartment is opened and closed during this 15 second window, flight mode will resume.

Listen to radio or TV

When listening to the TV or the radio, start out by listening to news commentators since they usually speak clearly, then try other programs. If you find it difficult to listen to TV or radio, your hearing care professional will be able to give you advice on available accessories to enhance your listening capabilities for TV and radio.

Telephone use

Finding the optimal position for holding a telephone may require practice for some individuals, and one or more of the following suggestions may be helpful.

1. Hold the telephone as you would normally.
2. Hold the telephone towards the top of the ear (closer to where the microphones are).
3. If whistling occurs, it may take a few seconds of holding the telephone in the same position before the hearing instrument eliminates the feedback.
4. Any whistling may also be decreased by holding the telephone slightly away from the ear.
5. Depending on your individual needs, your hearing care professional may activate a program specifically for telephone use.

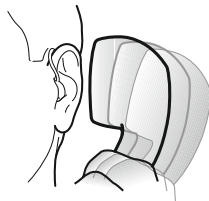

Using ReSound Hearing Instruments with iPhone®, iPad®, and iPod touch® (ReSound LiNX, ENZO and Up Smart)

ReSound LiNX, ENZO and Up Smart is a Made for iPhone instrument and allows for direct communication and control with an iPhone, iPad, or iPod touch. Note that MFi functionality is not supported in the LiNX 5, ENZO 5 and Up Smart 5 products. For assistance in pairing and using these products with your ReSound LiNX, ENZO and Up Smart device, please contact your hearing care professional or visit our support site at resound.com/linx.

Cellular phones

Your hearing instrument is designed to comply with the most stringent Standards of International Electromagnetic Compatibility. However, not all cell phones are hearing instrument compatible. The varying degree of disturbance can be due to the nature of your particular cellular phone or of your wireless telephone service provider.

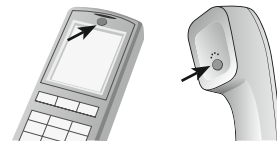

If you find it difficult to obtain a good result while using your cellular phone, your hearing care professional will be able to give you advice on available accessories to enhance listening capabilities.

PhoneNow

The PhoneNow function, allows your hearing instrument to automatically switch to your telephone program when a telephone receiver is raised to the ear. When the telephone receiver is removed from the ear, the hearing instrument automatically returns to the previous listening program.

Placement of PhoneNow magnets

Place PhoneNow magnet on your telephone receiver to allow operation of the PhoneNow function. In order to place PhoneNow magnet properly:

1. Clean the telephone receiver thoroughly.
2. Hold the telephone vertically, in a position similar to when making a telephone call.
3. Place the magnets just below the telephone receiver. Make sure not to cover the microphone openings. If necessary, move the magnet to another position to improve ease of use and comfort while speaking.
4. If you are not satisfied with the strength of PhoneNow, you can reposition the PhoneNow magnet or add additional PhoneNow magnets.

PhoneNow usage

Telephones can be used in a normal manner. A short melody will indicate that the PhoneNow feature has automatically switched the hearing instrument to your telephone program. Initially, you may need to move the telephone receiver slightly to find the best position for reliable PhoneNow activation and good hearing on the telephone.

If you have two hearing instruments with the synchronization function enabled, the volume of hearing instrument on the non-phone ear will be turned down.

 Only use recommended cleaning agent to clean the telephone prior to placing the magnet on the phone in order to obtain best possible adherence.

PhoneNow precautions

1. Keep magnets out of reach of pets, children and people with mental disabilities. If a magnet is swallowed, please seek advice from a medical practitioner.
2. The magnet may affect some medical devices or electronic systems. The manufacturer of any magnetically sensitive devices (e.g. pacemakers) should advise you regarding appropriate safety precautions when using your hearing instrument and magnet in close proximity to the medical device or electronic system in question. If the manufacturer cannot issue a statement, we recommend keeping the magnet or a telephone equipped with the magnet 30 cm (12") away from magnetically sensitive devices (e.g. pacemakers).
3. High distortion during dialing or phoning may mean that the magnet is not in the optimal position relative to the telephone receiver. To avoid the issue, please move the magnet to another place on the telephone receiver.
4. Only use magnets supplied by ReSound.

Telecoil (optional)

A telecoil can be activated by your hearing care professional and accessed through one of the additional programs. A telecoil picks up a telephone's magnetic signal and converts it to sound. An optional telephone program may help to improve speech understanding on the telephone. When using a telecoil program, the receiver of the telephone may need to be held closer to the hearing instrument. The handset of the telephone may need to be moved to slightly different positions in order to find the best reception.

Tele-loop systems

Many places, such as theaters, houses of worship, and schools are equipped with tele-loop systems. When using a telecoil program with tele-loop systems, sound is picked up directly and may improve speech understanding. If there is no sound from the hearing instruments in a tele-loop system and with a telecoil program activated, the tele-loop system may not be turned on or is not operating correctly. If a facility is not equipped with a tele-loop system, sitting as close as possible to the front may be helpful.

FM and Direct audio input (optional)

An FM system can greatly improve speech understanding in many situations such as when a speaker is a long distance away or a room is noisy or reverberant. The direct audio input (DAI) can be used with a universal FM receiver or together with a cable to connect to a radio, computer or television. The sound source is connected to the hearing instruments by a cable or a wireless FM system to the audio boot. This accessory connects to the bottom of the hearing instruments, and once properly clicked into place, the hearing instruments switches to DAI automatically.

Connecting/Disconnecting direct audio boot or integrated FM

Connecting audio boot and integrated FM

1. Align the tip of the audio boot or integrated FM boot with the groove just above the battery compartment and below the model number.
2. Once in place, move the boot in the direction of the battery compartment.
3. Gently click the boot onto the hearing instrument.

Disconnecting audio boot and integrated FM

4. Press and hold the button on the front side of the audio boot. For an FM boot, slide the latch downward with your finger nail.
5. Gently remove the boot from the hearing instrument.



Direct audio



Integrated FM

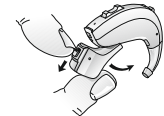
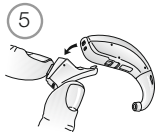
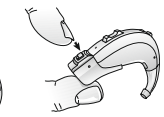
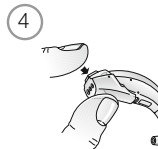
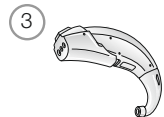

FM integrated with battery door (super power devices only)

1. Your hearing aid professional can replace the standard battery door with DAI audio boot or integrated FM receiver.

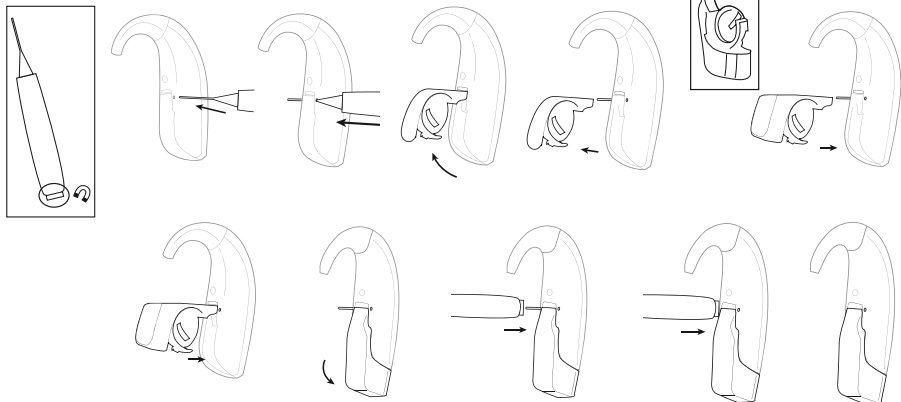
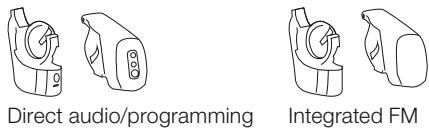

Important points for FM

- Do not use two transmitters on the same FM channel.
- Do not use water or fluids for cleaning FM boot.
- Do not use an FM transmitter in locations where it is forbidden to use electronic devices, for instance in airplanes.
- Be aware that FM signals might also be picked up and overheard by other receivers.
- Before using the system in another country, contact your hearing care professional to make sure your radio channel is permitted in that country.
- Your FM boot and transmitter may only be repaired by an authorized service center.

Battery door lock (optional)

Your hearing instrument can be equipped with a lock to prevent children or mentally challenged persons from accidentally ingesting the battery. Some pediatric instruments are equipped with an advanced battery locking system that automatically locks whenever the battery door is closed. Others need to be locked by sliding the color marker to the locked position. Ask your hearing care professional to demonstrate the locking system on your hearing instruments.

Advanced battery door lock

If your hearing instrument is equipped with an advanced battery door lock, the door is locked as soon as the battery door is closed. The lock is strong with a 2 kg (20N) retention force. The instrument will remain locked even when it is turned off. It only needs to be unlocked to replace the battery (See On/Off function – Page 10).

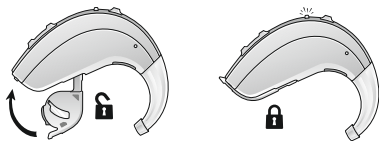

To replace the battery:

1. Place the instrument in the off position. The instrument is still locked.
2. Align the tip of the battery door release tool (Black), with the hole at the back of the instrument just below the volume control.
3. Press the tip into the hole perpendicular to the back of the instrument.



Important guidelines:

- Use only the provided battery-release tool.
- Hold the device on its sides keeping the battery door free to open.
- Before inserting the release tool, open the battery door to the “off” position.
- Insert release tool straight into the battery release hole. Do not press at an angle or pivot when pressing as this may damage the tool tip.

Your hearing care professional can provide you with additional tools if one is lost or damaged, or you require additional tools for other care givers.

The advanced battery door lock can be equipped with an additional safety feature. Your hearing care professional can install a colored silicone Left/Right side indicator which holds the battery securely making it difficult to remove without a tool. If equipped with this additional feature:

4. Use the battery door release tool to push the battery fully out.

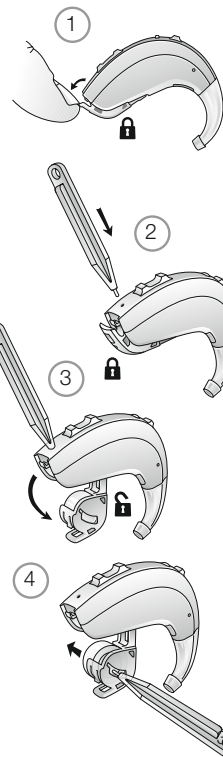

Advanced battery door lock (for Super Power devices only)

Super Power devices (marked as 90) are equipped with integrated advanced battery door lock. To operate lock use attached tool.

To lock the battery lock:

1. Insert tool straight into battery door lock.
2. Slide lock to the left.
3. Remove tool. Indication mark shows "lock" position - white dot appears. You can open the battery door to switch the device off but you can not open it to access the battery.

To unlock the battery lock (to replace the battery)

4. Insert tool straight into battery door lock.
5. Slide lock to the right.
6. Remove tool. No indication mark shows "unlock" position. You can open battery door fully to exchange the battery.

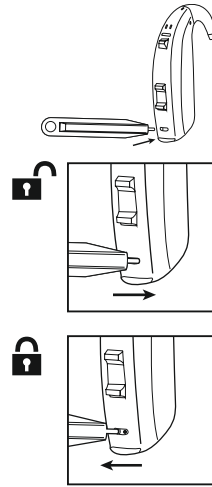

Standard battery door lock

Your hearing care professional can install a Left/Right side indicator which can be used to lock the battery door. Once locked, the instrument can only be turned off once the instrument is unlocked again.

To lock the battery door:

1. Close the battery door
2. Using the battery door locking tool (Light Blue), slide the color marker (Blue=Left, Red=Right) to the right.

To unlock the battery door:

3. Slide the color maker to the left.

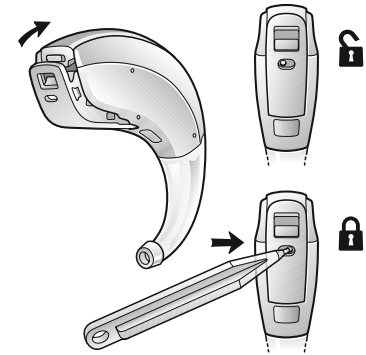

i Care and maintenance

Please follow the following instructions to prolong the durability of your hearing instruments:

1. Keep your hearing instrument clean and dry. Wipe the case with a soft cloth or tissue after use to remove grease or moisture. Do not use water or solvents, as these can damage the hearing instrument(s).
2. Never immerse hearing instruments in water or other liquids, as liquids may cause permanent damage to the hearing instruments.
3. Avoid rough handling of hearing instruments or dropping them on hard surfaces or floors.
4. Do not leave hearing instruments in or near direct heat or sunlight, such as in a hot, parked car, as excessive heat can cause damage or deform the casing.
5. Do not wear your instrument while showering, swimming, in heavy rain or in a moist atmosphere such as a steam bath or sauna.
6. If your instrument does get wet, or if it has been exposed to high humidity or perspiration, it should be left to dry out overnight with the battery out and the battery compartment open. It is also a good idea to put the instrument and battery in a sealed container together with a drying agent (desiccator) overnight. Do not use the instrument until it is completely dry. Consult your hearing care professional as to which drying agent to use.
7. Remove your hearing instrument when applying such things as cosmetics, perfume, aftershave, hair spray, and suntan lotion. These might get into the instrument and cause damage.

i Daily maintenance

It is important to keep your hearing instrument clean and dry. On a daily basis, clean the hearing instruments using a soft cloth or tissue. In order to avoid damage due to humidity or excessive perspiration, the use of a drying kit is recommended.

i Cleaning earmolds

1. Remove the earmold and attached tubing from the hearing instruments prior to cleaning.
2. Clean the earmold using a mild soap, and rinse with lukewarm water.
3. After cleaning, dry earmolds thoroughly and remove any residual water and debris from the tubing utilizing an air bulb and wire loop.

i Note: Earmold tubing may become stiff, brittle, or discolored over time. Contact your hearing care professional regarding tube changes.

i Cleaning thin tubes and domes

1. Remove thin tubes from hearing instruments before cleaning by unscrewing them counter clockwise.
2. Wipe down thin tubes and domes with a damp cloth.
3. In order to clear the thin tube of moisture and debris, push the black cleaning rod through the thin tube, beginning at the end opposite the dome.

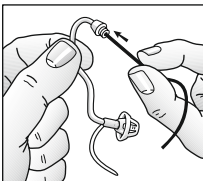

Note: Thin tube and dome systems should be changed every three months or sooner, should the components become stiff or brittle.

Cleaning metal hook

Some hearing instruments are equipped with a metal power hook. Regular cleaning is required to keep these hooks in new condition.

1. Remove the earmold and tubing from the metal power hook. Clean these as above.
2. Using a soft cloth or tissue wipe off any moisture, perspiration, or debris from the surface of the hook.

 Note: Do not use alcohol or other cleaning solvents to clean the metal hook as this could damage the protective covering.

How to apply domes

It is recommended that your hearing care professional change domes, as incorrect dome replacement could result in the dome falling out in the ear.

ReSound Standard domes

1. Push the new dome over the flanges on the thin tube.
2. Make sure that the new dome is properly and securely mounted.

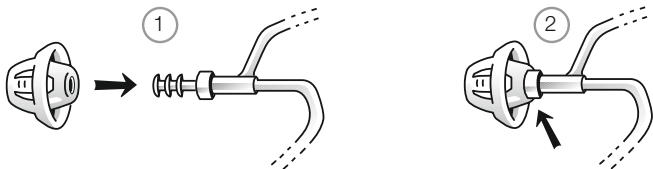

ReSound Tulip domes

Tulip domes are mounted in a similar manner to standard domes, but a few extra steps are required. Tulip domes consist of two “petals”. It is important to note that the largest petal is the outermost petal. To ensure this:

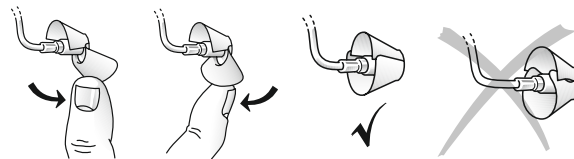

1. Push the largest petal away from the thin tube using a finger. This bends the petal forward.
2. Then push the largest petal back, and it will be placed on top of the smaller petal.

Using ReSound hearing instruments with smart phone apps

 Intended use of smart phone apps:

GN ReSound smart phone apps are intended to be used with GN ReSound wireless hearing aids. GN ReSound smart phone apps send and receive signals from the GN ReSound wireless hearing aids via smart phones for which the apps have been developed.

Use with smart phone apps:

- Notifications of app updates should not be disabled, and it is recommended that the user installs all updates to ensure that the app will function correctly and will be kept up to date.
- The app must only be used with GN ReSound devices for which it is intended, and GN ReSound take no responsibility if the app is used with other devices.



General precautions

1. Do not leave hearing instruments in the sun, near an open fire, or in a hot, parked car.
2. Do not wear hearing instruments while showering, swimming, in heavy rain, or in a moist atmosphere such as a steam bath or sauna.
3. Should the hearing instrument become moist, remove the battery and place the hearing instrument in a closed container with a drying agent. Your hearing care professional can provide options for drying containers or kits.
4. Remove the hearing instruments when applying items such as cosmetics, perfume, after-shave, hair spray, and suntan lotion.
5. When wireless function is activated, the device uses low-powered digitally coded transmissions in order to communicate with other wireless devices. Although unlikely, nearby electronic devices may be affected. In that case, move the hearing instrument away from the affected electronic device.
6. When using wireless functionality and the devices are affected by electromagnetic interference, move away from the source.
7. Use only original GN ReSound consumables e.g. tubes and domes. Never attempt to modify the shape of the hearing instrument, earmolds, or tubing yourself.
8. Only connect ReSound hearing instruments to ReSound accessories intended and qualified to be used with ReSound hearing instruments.



General warnings

1. Consult a hearing care professional if you think there may be a foreign object in your ear canal, if you experience skin irritation, or if excessive ear wax accumulates with the use of the hearing instrument.
2. Different types of radiation, from e.g. NMR, MRI, or CT scanners, may damage hearing instruments. It is recommended not to wear hearing instruments during these or other similar procedures. Other types of radiation, such as burglar alarms, room surveillance systems, radio equipment, mobile telephones, contain less energy and will not damage hearing instruments. However, they have the potential to momentarily affect the sound quality or temporarily create strange sounds from hearing instruments.
3. Do not wear hearing instruments in mines, oil fields, or other explosive areas unless those areas are certified for hearing instrument use.
4. Do not allow others to use your hearing instruments. This may cause damage to the hearing instruments or to the hearing of the other individual.
5. Instrument usage by children or mentally challenged persons should be supervised at all times to ensure their safety. The hearing instrument contains small parts that could be swallowed by children. Please be mindful not to leave children unsupervised with this hearing instrument.
6. Hearing instruments should be used only as prescribed by your hearing care professional. Incorrect use may result in hearing loss.
7. Warning to hearing care professionals: Special care should be exercised in selecting and fitting hearing instruments with maximum sound pressure level that exceeds 132dB SPL with an IEC 60711:1981 occluded ear simulator. There may be a risk of impairment of the remaining hearing.
8. Be careful when boarding flights to deactivate the wireless functionality. Turn off your wireless functionality by using the flight mode in areas where radio frequency emission is prohibited.
9. If device is broken, do not use.

10. External devices connected to the electrical input must be safe according to the requirements of IEC 60601-1-1, IEC 60065, or IEC 60950-1, as appropriate (wired connection, f.ex. HI-PRO), SpeedLink).



Note:

- * ReSound wireless devices operate in the frequency range of 2.4 GHz - 2.48 GHz.
- * ReSound wireless devices include a RF transmitter that operates in the range of 2.4 GHz - 2.48 GHz.
- * Nominal RF output power transmitted is 0 dBm.
- * For use of wireless functionality only use ReSound Unite accessories. For further guidance regarding e.g. pairing, please refer to the user guide of the relevant ReSound Unite accessory.

Tinnitus Sound Generator (TSG) module

Intended use for the TSG module

Your ReSound hearing instruments may also include the Tinnitus Sound Generator function, a tool for generating sounds to be used in tinnitus management programs to relieve suffering from tinnitus.



TSG warnings

- Sound generators can be dangerous if improperly used.
- Sound generators should be used only as advised by your doctor, audiologist, or hearing healthcare professional.
- Sound generators are not toys and should be kept out of reach of anyone who might cause themselves injury (especially children and pets).

User instructions for the TSG module

Description of the device

The Tinnitus Sound Generator (TSG) Module is a software tool that generates sounds to be used in tinnitus management programs to relieve suffering from tinnitus.

Explanation of how the device functions

The TSG module is a frequency and amplitude shaped white-noise generator. Noise signal level and frequency characteristics can be adjusted to the specific therapeutic needs as determined by your doctor, audiologist or hearing healthcare professional.

Your doctor, audiologist or hearing healthcare professional can modulate the generated noise with the purpose of making it more pleasant. The noise can then resemble, for example, crushing waves on a shore.

Modulation level and speed can also be configured to your likes and needs. If you have two wireless hearing aids that support ear to ear synchronization this functionality can be enabled by your hearing healthcare professional. This will cause the Tinnitus Sound Generator to synchronize the sound in both hearing aids. If your tinnitus troubles you only in quiet environments, your doctor, audiologist or hearing healthcare professional can set the TSG Module so that it becomes audible exclusively in such surroundings. The overall sound level can be adjusted via an optional volume control. Your doctor, audiologist or hearing healthcare professional will review with you the need for having such a control. For hearing aids where ear to ear synchronization is enabled your hearing healthcare professional can also enable environmental monitoring synchronization so that the TSG noise level is automatically adjusted simultaneously in both hearing aids dependent on the background sound level. Additionally if the hearing aid has a volume control then the background noise level monitored by the hearing aid and the volume control can be used simultaneously to adjust the generated noise level in both hearing aids.

TSG volume control

The sound generator is set to a specific loudness level by the hearing healthcare professional. When switching the sound generator on, the volume will have this optimal setting. Therefore, it might not be necessary to control the volume (loudness) manually. However, the volume control provides the ability to adjust the volume, or amount of stimulus, to the liking of the user.



Caution

- The volume control is an optional feature in the TSG module used for adjusting the sound generator output level. To prevent unintended usage by pediatric or physically or mentally challenged users, the volume control must, if enabled, be configured to only provide a decrease of the sound generator output level.



TSG precautions

- Should the user develop any side effects from using the sound generator, such as dizziness, nausea, headaches, perceived decrease in auditory function or increase in tinnitus perception, the user should discontinue use of the sound generator and seek medical evaluation.
- Children and physically or mentally challenged users will require guardian supervision while wearing the TSG hearing instrument.

The scientific concepts that form the basis for the device

The TSG module provides sound enrichment with the aim of surrounding the tinnitus sound with a neutral sound which is easily ignored. Sound enrichment is an important component of most approaches to tinnitus management, such as Tinnitus Retraining Therapy (TRT). To assist habituation to tinnitus, this needs to be audible. The ideal level of the TSG module, therefore, should be set so that it starts to blend with the tinnitus, and so that you can hear both your tinnitus as well as the sound used.

In a majority of instances, the TSG module can also be set to mask the tinnitus sound, so to provide temporary relief by introducing a more pleasant and controllable sound source.

Significant physical characteristics

Audio signal technology

Digital

Available sounds

White noise signal which can be shaped with the following configurations:

The white noise signal can be modulated in amplitude with an attenuation depth of up to 14dB.

High-pass filter	Low-pass filter
500 Hz	2000 Hz
750 Hz	3000 Hz
1000 Hz	4000 Hz
1500 Hz	5000 Hz
2000 Hz	6000 Hz

Should you develop any side effects from using the sound generator, such as dizziness, nausea, headaches, perceived decrease in auditory function or increase in tinnitus perception, you should discontinue use of sound generator and seek medical evaluation.

The target population is primarily the adult population over 18 years of age. This product may also be used with children 5 years of age or older. However, children and physically or mentally challenged users will require training by a doctor, audiologist, hearing healthcare professional or the guardian for the insertion and removal of the hearing instrument containing the TSG module.

Important notice for prospective sound generator users

A tinnitus masker is an electronic device intended to generate noise of sufficient intensity and bandwidth to mask internal noises. It is also used as an aid in hearing external noises and speech.

Good health practice requires that a person with a tinnitus condition have a medical evaluation by a licensed physician (preferably a physician who specializes in diseases of the ear) before using a sound generator. Licensed physicians who specialize in diseases of the ear are often referred to as otolaryngologists, otologists or otorhinolaryngologists.

The purpose of medical evaluation is to assure that all medically treatable conditions that may affect tinnitus are identified and treated before the sound generator instrument is used.

The sound generator instrument is a tool to generate sounds to be used with appropriate counselling and/or in a tinnitus management program to relieve patients suffering from tinnitus.

Prescription use of this TSG hearing instrument

The TSG module should be used as prescribed by your doctor, audiologist or hearing healthcare professional. In order to avoid permanent hearing damages, the maximum daily usage depends on the level of the generated sound.



TSG warning to hearing healthcare professionals

A hearing healthcare professional should advise a prospective sound generator user to consult promptly with a licensed physician (preferably an ear specialist) before getting a sound generator if the hearing healthcare professional determines through inquiry, actual observation, or review of any other available information concerning the prospective user that the prospective user has any of the following conditions:

- (i) Visible congenital or traumatic deformity of the ear.
- (ii) History of active drainage from the ear within the previous 90 days.
- (iii) History of sudden or rapidly progressive hearing loss within the previous 90 days.
- (iv) Acute or chronic dizziness.
- (v) Unilateral hearing loss of sudden or recent onset within the previous 90 days.
- (vi) Audiometric air-bone gap equal to or greater than 15dB at 500 hertz (Hz), 1000 Hz, and 2000 Hz.
- (vii) Visible evidence of significant cerumen accumulation or a foreign body in the ear canal.
- (viii) Pain or discomfort in the ear.



CAUTION: The maximum output of the sound generator falls into the range that can cause hearing loss according to OSHA regulations. In accordance with NIOSH recommendations the user should not use the sound generator for more than eight (8) hours a day when this is set to a level of 85db SPL or above. When the sound generator is set to levels of 90db SPL or above the user should not use the sound generator for more than two (2) hours per day. In no case should the sound generator be worn at uncomfortable levels.



Battery warning information

Batteries, although very small, contain dangerous substances, and should be disposed of carefully. This is for the safety of you and the environment. Please note:

1. Do not attempt to recharge batteries (Zinc Air) which are not specifically designated as rechargeable because they may leak or explode.
2. DO NOT attempt to dispose of batteries by burning them. Used batteries are harmful to the environment. Please dispose of them according to local regulations or return them to your hearing care practitioner.
3. DO NOT place batteries in your mouth. Consult a physician immediately if a battery has been swallowed, as they can be harmful to your health.
4. Keep batteries away from pets, children and individuals who are mentally challenged.
5. Remove the batteries to prevent leakage when the hearing instruments are not in use for an extended period of time.



Hearing instrument expectations

A hearing instrument will not restore normal hearing and will not prevent or improve a hearing impairment resulting from organic conditions. Consistent use of the hearing instrument is recommended. In most cases, infrequent use does not permit you to attain full benefit from it.

The use of a hearing instrument is only part of hearing rehabilitation and may need to be supplemented by auditory training and instructions in lip-reading.



Warning to hearing aid dispensers (US Only)

A hearing aid dispenser should advise a prospective hearing aid user to consult promptly with a licensed physician (preferably an ear specialist) before dispensing a hearing aid if the hearing aid dispenser determines through inquiry, actual observation, or review of any other available information concerning the prospective user, that the prospective user has any of the following conditions:

- (i) Visible congenital or traumatic deformity of the ear.
- (ii) History of active drainage from the ear within the previous 90 days.
- (iii) History of sudden or rapidly progressive hearing loss within the previous 90 days.
- (iv) Acute or chronic dizziness.
- (v) Unilateral hearing loss of sudden or recent onset within the previous 90 days.
- (vi) Audiometric air-bone gap equal to or greater than 15 decibels at 500 hertz (Hz), 1,000 Hz, and 2,000 Hz.
- (vii) Visible evidence of significant cerumen accumulation or a foreign body in the ear canal.
- (viii) Pain or discomfort in the ear.

Important notice for prospective hearing aid users (US Only)

Good health practice requires that a person with a hearing loss have a medical evaluation by a licensed physician (preferably a physician who specializes in diseases of the ear) before purchasing a hearing aid. Licensed physicians who specialize in diseases of the ear are often referred to as otolaryngologists, otologists or otorhinolaryngologists. The purpose of medical evaluation is to assure that all medically treatable conditions that may affect hearing are identified and treated before the hearing aid is purchased.

Following the medical evaluation, the physician will give you a written statement that states that your hearing loss has been medically evaluated and that you may be considered a candidate for a hearing aid. The physician will refer you to an audiologist or a hearing aid dispenser, as appropriate, for a hearing aid evaluation. The audiologist or hearing aid dispenser will conduct a hearing aid evaluation to assess your ability to hear with and without a hearing aid. The hearing aid evaluation will enable the audiologist or dispenser to select and fit a hearing aid to your individual needs. If you have reservations about your ability to adapt to amplification, you should inquire about the availability of a trial-rental or purchase-option program. Many hearing aid dispensers now offer programs that permit you to wear a hearing aid for a period of time for a nominal fee after which you may decide if you want to purchase the hearing aid.

Federal law restricts the sale of hearing aids to those individuals who have obtained a medical evaluation from a licensed physician. Federal law permits a fully informed adult to sign a waiver statement declining the medical evaluation for religious or personal beliefs that preclude consultation with a physician. The exercise of such a waiver is not in your best health interest and its use is strongly discouraged.

Children with hearing loss (US Only)

In addition to seeing a physician for a medical evaluation, a child with a hearing loss should be directed to an audiologist for evaluation and rehabilitation since hearing loss may cause problems in language development and the educational and social growth of a child. An audiologist is qualified by training and experience to assist in the evaluation and rehabilitation of a child with a hearing loss.

Technical data

MINI BTE

Models: AL967-DIW, AL767-DIW, AL567-DIW, AL467-DIW, ALT967-DIW, ALT767-DIW

		Open	Closed	
Reference test gain (60 dB SPL input)	HFA	36	41	dB
Full-on gain (50 dB SPL Input)	Max	51	54	dB
	HFA	44	48	dB
Maximum output (90 dB SPL input)	Max	119	123	dB SPL
	HFA	113	117	dB SPL
Total harmonic distortion	500 Hz	0.5	2.0	%
	800 Hz	0.1	1.4	%
	1600 Hz	0.4	0.3	%
Telecoil sensitivity (SPLIV @ 31.6 mA/m)		96	99	dB SPL
Equivalent input noise (w/o noise reduction)		23	23	dB SPL
Frequency range (DIN 45605)		100–6940	100–6870	Hz
Current drain (in test mode)		1.2	1.2	mA

Data in accordance with ANSI S3.22-2009; and IEC 60118-7 ed.2.0 Supply Voltage 1.3 V, 2cc coupler

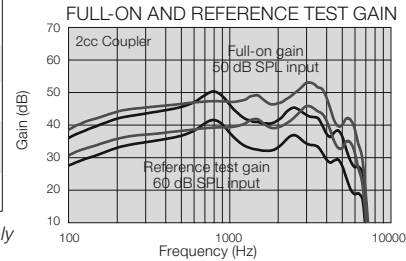
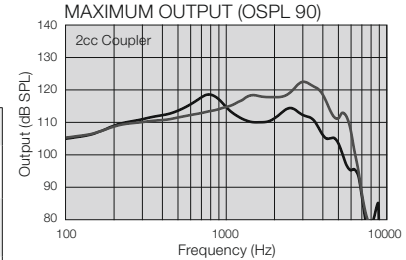

— Open configuration
 - - - Closed configuration

BTE

Models: AL977-DVIW, AL777-DVIW, AL577-DVIW, AL477-DVIW, ALT977-DVIW, ALT777-DVIW, ALT577-DVIW

		Open	Closed	
Reference test gain (60 dB SPL input)	HFA	39	45	dB
Full-on gain (50 dB SPL Input)	Max	51	59	dB
	HFA	45	50	dB
Maximum output (90 dB SPL input)	Max	123	127	dB SPL
	HFA	117	122	dB SPL
Total harmonic distortion	500 Hz	0.2	0.7	%
	800 Hz	0.3	1.4	%
	1600 Hz	0.6	0.8	%
Telecoil sensitivity (SPLIV @ 31.6 mA/m)		100	106	dB SPL
Equivalent input noise (w/o noise reduction)		27	25	dB SPL
Frequency range (DIN 45605)		100–6740	100–6850	Hz
Current drain (in test mode)		1.2	1.2	mA

Data in accordance with ANSI S3.22-2009; and IEC 60118-7 ed.2.0 Supply Voltage 1.3 V, 2cc coupler

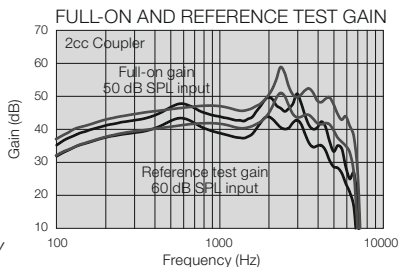
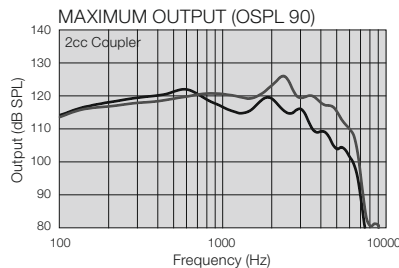

— Open configuration
 - - - Closed configuration

POWER BTE

Models: AL987-DVIW, AL787-DVIW, AL587-DVIW, AL487-DVIW, ALT987-DVIW, ALT787-DVIW, ALT587-DVIW

Reference test gain (60 dB SPL input)	HFA	49	dB
Full-on gain (50 dB SPL Input)	Max	67	dB
	HFA	61	dB
Maximum output (90 dB SPL input)	Max	130	dB SPL
	HFA	127	dB SPL
Total harmonic distortion	500 Hz	2.0	%
	800 Hz	0.6	%
	1600 Hz	0.6	%
Telecoil sensitivity (SPLIV @ 31.6 mA/m)		111	dB SPL
Equivalent input noise (w/o noise reduction)		22	dB SPL
Frequency range (DIN 45605)		100–6400	Hz
Current drain (in test mode)		1.2	mA

Data in accordance with ANSI S3.22-2009; and IEC 60118-7 ed.2.0 Supply Voltage 1.3 V, 2cc coupler

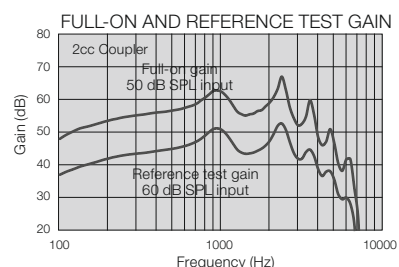
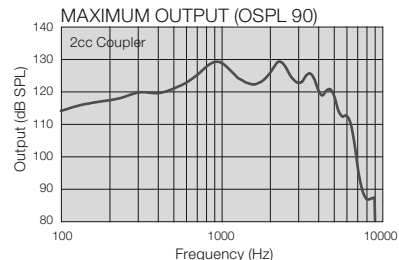

MINI BTE

Models: V0967-DW, V0767-DW, V0567-DW, V0T967-DW, V0T767-DW, UP967-DW, UP767-DW

		Open	Closed	
Reference test gain (60 dB SPL input)	HFA	36	40	dB
Full-on gain (50 dB SPL Input)	Max	51	55	dB
	HFA	46	49	dB
Maximum output (90 dB SPL input)	Max	117	122	dB SPL
	HFA	112	117	dB SPL
Total harmonic distortion	500 Hz	0.8	1.8	%
	800 Hz	0.2	1.5	%
	1600 Hz	0.5	0.5	%
Telecoil sensitivity (SPLIV @ 31.6 mA/m)		95	98	dB SPL
Equivalent input noise (w/o noise reduction)		22	22	dB SPL
Frequency range (DIN 45605)		100–7040	100–7110	Hz
Current drain (in test mode)		1.1	1.1	mA

Data in accordance with ANSI S3.22-2009; and IEC 60118-7 ed.2.0 Supply Voltage 1.3 V, 2cc coupler

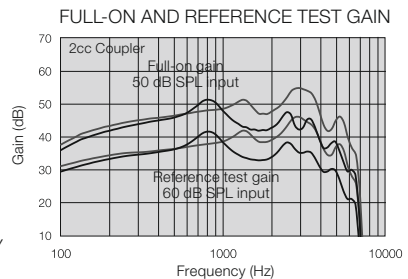
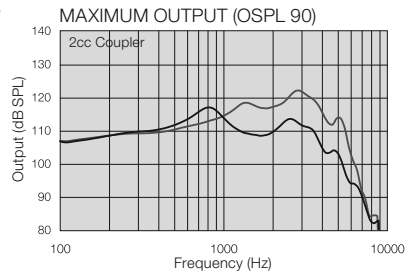

— Open configuration
— Closed configuration

BTE

Models: V0977-DW, V0777-DW, V0577-DW, V0T977-DW, V0T777-DW, UP977-DLW, UP977-DW, UP777-DLW, UP777-DW, UPS977-DLW, UPS777-DLW, UPS577-DLW, UPS577M-DLW, LN977-DW, LN777-DW, LN577-DW, LNT977-DW, LNT777-DW

		Open	Closed	
Reference test gain (60 dB SPL input)	HFA	41	47	dB
Full-on gain (50 dB SPL Input)	Max	51	59	dB
	HFA	46	52	dB
Maximum output (90 dB SPL input)	Max	122	128	dB SPL
	HFA	118	123	dB SPL
Total harmonic distortion	500 Hz	0.1	0.4	%
	800 Hz	0.2	0.4	%
	1600 Hz	0.5	0.5	%
Telecoil sensitivity (SPLIV @ 31.6 mA/m)		100	107	dB SPL
Equivalent input noise (w/o noise reduction)		23	22	dB SPL
Frequency range (DIN 45605)		100–6770	100–6850	Hz
Current drain (in test mode)		1.1	1.1	mA

Data in accordance with ANSI S3.22-2009; and IEC 60118-7 ed.2.0 Supply Voltage 1.3 V, 2cc coupler

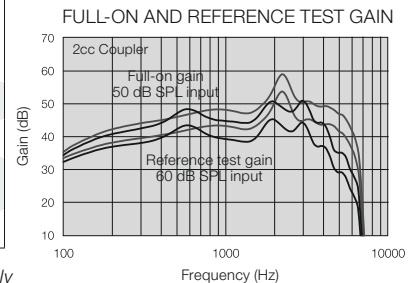
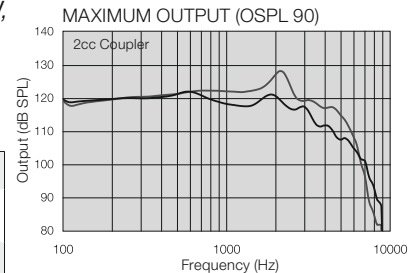

— Open configuration
— Closed configuration

POWER BTE

Models: V0988-DW, V0788-DW, V0588-DW, V0T988-DW, V0T788-DW, UP988-DLW, UP988-DW, UP788-DLW, UP788-DW, UPS988-DLW, UPS788-DLW, UPS588-DLW, UPS588M-DLW, LN988-DW, LN788-DW, LN588-DW, LNT988-DW, LNT788-DW

		Power	High Power	
Reference test gain (60 dB SPL input)	HFA	51	50	dB
Full-on gain (50 dB SPL Input)	Max	67	72	dB
	HFA	62	68	dB
Maximum output (90 dB SPL input)	Max	131	131	dB SPL
	HFA	128	128	dB SPL
Total harmonic distortion	500 Hz	1.0	0.7	%
	800 Hz	0.4	0.4	%
	1600 Hz	0.5	0.3	%
Telecoil sensitivity (SPLIV @ 31.6 mA/m)		111	110	dB SPL
Equivalent input noise (w/o noise reduction)		20	21	dB SPL
Frequency range (DIN 45605)		100–6170	100–4960	Hz
Current drain (in test mode)		1.1	1.1	mA

High Power configuration not available for LiNX Power BTE form factors
Data in accordance with ANSI S3.22-2009; and IEC 60118-7 ed.2.0 Supply Voltage 1.3 V, 2cc coupler

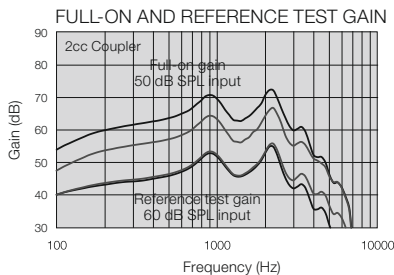
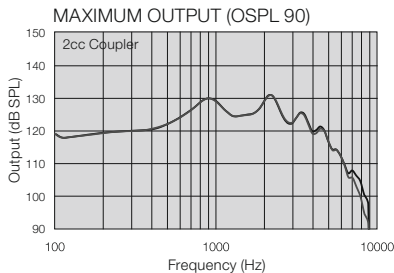

— High Power
— Normal Power

SUPER POWER BTE

Models: UPS998-DLW, UPS798-DLW, UPS598-DLW, UPS598M-DLW, E0998-DW, E0798-DW, E0598-DW

Reference test gain (60 dB SPL input)	HFA	54	dB
Full-on gain (50 dB SPL Input)	Max	83	dB
	HFA	69	dB
Maximum output (90 dB SPL input)	Max	141	dB SPL
	HFA	131	dB SPL
Total harmonic distortion	500 Hz	4,0	%
	800 Hz	0,7	%
	1600 Hz	0,9	%
Telecoil sensitivity (1 mA/m input)	Max	-	dB SPL
	HFA – SPLIV @ 31.6 mA/m (ANSI)	HFA	116
	Full-on Telecoil sensitivity @ 1mA/m	HFA	101
Equivalent input noise w/o Noise reduction		26	dB SPL
1/3 Octave Equivalent input noise, w/o Noise reduction		-	dB SPL
Frequency range (DIN 45605)		100–5860	Hz
Current drain (in test mode)		1,3	mA

Data in accordance with ANSI S3.22-2009; and IEC 60118-7 ed.2.0 Supply Voltage 1.3 V, 2cc coupler

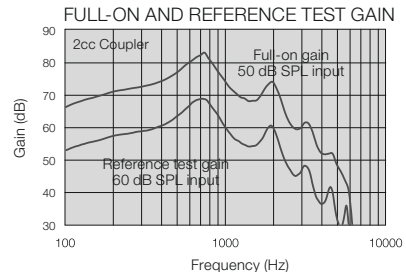
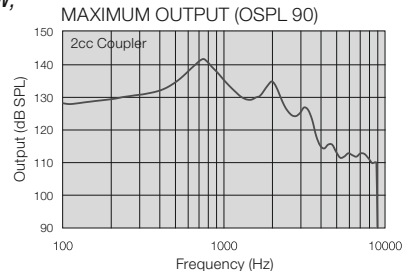

Troubleshooting Guide

SYMPTOM	CAUSE	POSSIBLE REMEDY
No sound	Not turned on	Turn on by closing the battery door
	Dead battery	Replace battery
	Battery door will not close	Insert battery properly
	Blocked earmold or tube	Clean earmold or tube
	Blocked wax filter	Replace wax filter or consult your hearing care professional
	Stand by mode (ENZO and Up Smart 98 models)	Press volume control up button
Not loud enough	Incorrect earmold placement	Reinsert earmold
	Blocked earmold or dome	Clean earmold, replace dome, replace filter
	Blocked sound outlet filter	Change filter or consult your hearing care professional
	Change in hearing sensitivity	Consult your hearing care professional
	Excessive ear wax	Consult your physician
	Volume set too low	Increase the volume control if available or consult your hearing care professional
	Minimum volume (ENZO and Up Smart 98 models)	Press volume control up button

Troubleshooting Guide

SYMPTOM	CAUSE	POSSIBLE REMEDY
Excessive whistling / feed-back	Incorrect earmold placement	Re-insert earmold carefully
	Incorrect dome placement	Re-insert dome
	Excessive ear wax	Consult your hearing care professional
	Feedback control may need adjustment	Consult your hearing care professional
	Earmold tubing worn or damaged	Consult your hearing care professional
	Thin tube connection loose	Change thin tube or consult your hearing care professional
	Hearing instrument settings not optimal	Consult your hearing care professional
Sound distorted / not clear	Weak battery	Replace battery
	Improper earmold or dome fit	Consult your hearing care professional
	Hearing instrument damaged	Consult your hearing care professional
	Hearing instrument settings not optimal	Consult your hearing care professional
Wireless does not work	Possible Root Cause - Device is in flight mode	For Alera devices with push button: Open and close the battery compartment. For Alera devices without push button: Open and close the battery door twice within 10 seconds For all Verso devices: Open and close the battery compartment once. Wireless will reactivate 10 seconds later. (If Root Cause is device in flight mode)

Warranty and repairs

ReSound provides a warranty on hearing instruments in the event of defects in workmanship or materials, as described in applicable warranty documentation. In its service policy, ReSound pledges to secure functionality at least equivalent to the original hearing instrument. As a signatory to the United Nations Global Compact initiative, ReSound is committed to doing this in line with environment-friendly best practices. Hearing instruments therefore, at ReSound's discretion, may be replaced by new products or products manufactured from new or serviceable used parts, or repaired using new or refurbished replacement parts. The warranty period of hearing instruments is designated on your warranty card, which is provided by your hearing care professional.

For hearing instruments that require service, please contact your hearing care professional for assistance. ReSound hearing instruments that malfunction must be repaired by a qualified technician. Do not attempt to open the case of hearing instruments, as this will invalidate the warranty.

Temperature test, transport and storage information

GN ReSound Hearing Instruments are subjected to various tests in temperature and damp heating cycling between -25 C and +70C according to internal and industry standards.

During transport or storage, the temperature should not exceed the limit values of -20C to 60C and relative humidity of 90% RH, non condensing (for limited time). The air pressure between 500 and 1100 hPa is appropriate.

Be aware of information marked with the warning symbol



WARNING points out a situation that could lead to serious injuries,
CAUTION indicates a situation that could lead to minor and moderate injuries



Advice and tips on how to handle your hearing instrument better.



Equipment includes RF transmitter

ReSound LiNX, ENZO and Up Smart are compatible with iPhone 8 Plus, iPhone 8, iPhone 7 Plus, iPhone 7, iPhone 6s Plus, iPhone 6s, iPhone 6 Plus, iPhone 6, iPhone SE, iPhone 5s, iPhone 5c, iPhone 5, iPad Pro (10.5-inch), iPad Pro (12.9-inch), iPad Pro (9.7-inch), iPad Air 2, iPad Air, iPad mini 4, iPad mini 3, iPad mini 2, iPad mini, iPad (5th generation), iPad (4th generation), iPod touch (6th generation) and iPod touch (5th generation) using iOS 8.0 or later. Apple, the Apple logo, iPhone, iPad Pro, iPad Air, iPad mini, iPad and iPod touch are trademarks of Apple Inc., registered in the U.S. and other countries.



“Made for iPhone” means that an electronic accessory has been designed to connect specifically to iPhone and has been certified by the developer to meet Apple performance standards. Apple is not responsible for the operation of this device or its compliance with safety and regulatory standards. Please note that the use of this accessory with iPhone may affect wireless performance.



Please ask your local hearing care professional concerning disposal of your hearing instrument

Manufacturer according to
EU Medical Device
Directive 93/42/EEC:

GN ReSound A/S
Lautrupbjerg 7
DK-2750 Ballerup
Denmark
Tel.: +45 4575 1111
resound.com

CVR no. 55082715

Manufacturer according
to FDA:

GN ReSound North America
8001 E Bloomington Freeway
Bloomington, MN 55420
USA
1-888-735-4327
resound.com

ReSound Government Services
8001 E Bloomington Freeway
Bloomington, MN 55420
USA
1-800-392-9932
resound.com/veterans

Manufacturer according
to Health Canada:

ReSound Canada
303 Supertest Road
Toronto, ON M3J 2M4
Canada
1-888-737-6863
resound.com



Any issues relating to the EU Medical Device Directive 93/42/EEC or EU Radio
Equipment Directive 2014/53/EU should be directed to GN ReSound A/S.

